

# Data sheet - Clamped waterstop series



## **PRODUCT SPECIFICATION**

SK H2O protec clamped waterstop types KFB, FM, AM and FAE according to DIN 7865, part 2 are permanently flexible profiles made of elastomer, SBR or EPDM, that are used as replacement sealing in waterproof concrete structures with large movements and high water pressures.

For subsequent sealing of joints using loose-type flange or fixed flange constructions.

## **Characteristics / Advantages**

- high tensile strength and elongation at break
- high permanent flexibility and high-load bearing capacity
- suitable for water pressure and large settlements
- resistant to all natural media acting aggressively to concrete
- resistant to a wide range of chemical substances (tests required for each additional specific situation)
- resistant to bitumen
- supply of systems for easy handling on site
- vulcanizable by using butt joints on site

## **Application**

- joint sealing in concrete structures
- sealing system for in-situ concrete

### Typical structures

- underground car parks, bridges, trough and bridge constructions
- rail tunnels and road tunnels
- water construction plants

# Data sheet - Clamped waterstop series



## **Standards / Directives**

- DIN 18197
- DIN 7865, part 2
- WU- Directives DAfStb
- ZTV-ING, Riz-Ing
- Vulcanizing instructions

## **Test certificate / Approvals**

- latest manufacturer's test certificate
- certificate of conformity - DIN 7865
- external monitoring by MPA NRW
- internal monitoring

## **PRODUCT DATA**

### **Material** Types: KFB, FM, AM

- SBR elastomer (styrene butadiene rubber)
- EPDM elastomer (ethylene-propylene-diene monomer)

### **Colour** Types: KFB, FM, AM

- black

### **Material** Type: FAE

- EPDM elastomer (ethylene-propylene-diene monomer)

### **Colour** Type: FAE

- black with grey visible surface

### **Packaging**

- supplied as standard rolls (25 m)

# Data sheet - Clamped waterstop series



---

## MECHANICAL PROPERTIES according to DIN 7865, part 2

---

<b>Shore A hardness</b>	62 ± 5
<b>Tear strength</b>	≥ 10 MPa
<b>Elongation at break</b>	≥ 380 %
<b>Compression set</b>	168h / 23°C ≤ 20% 24h / 70°C ≤ 35%
<b>Tear propagation resistance</b>	≥ 8 kN/m
<b>Performance after heat ageing</b>	Shore A hardness change ≤ 8 Tear strength ≥ 9 MPa Elongation at break ≥ 300%
<b>Low temperature performance</b>	≤ 90 Shore A
<b>Tension set</b>	≤ 20%
<b>Performance after conditioning in hot bitumen</b>	Residual deformation < 20% Tear strength ≥ 7 MPa Elongation at break ≥ 300%
<b>Performance after ozone ageing</b>	No cracks

---

# Data sheet - Clamped waterstop series



KFB 330

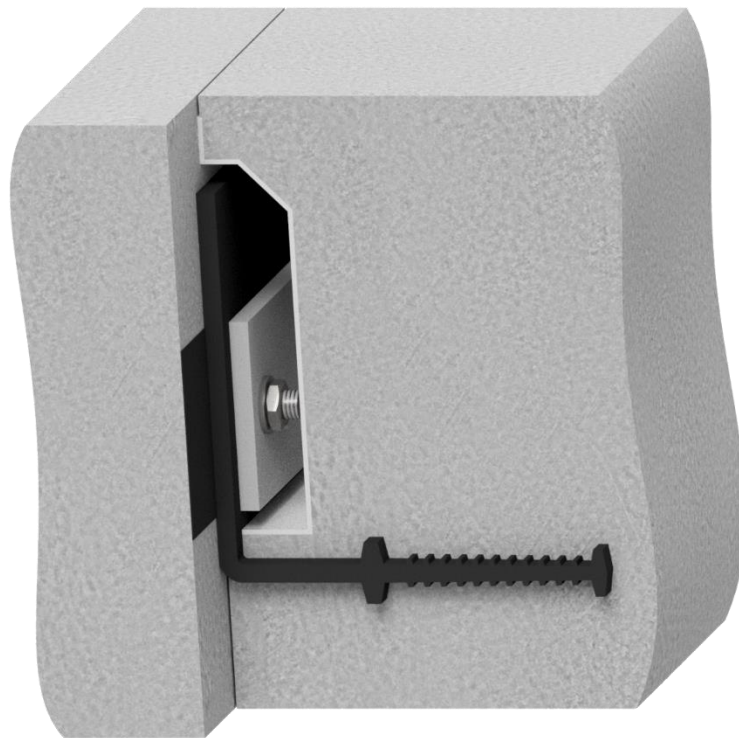
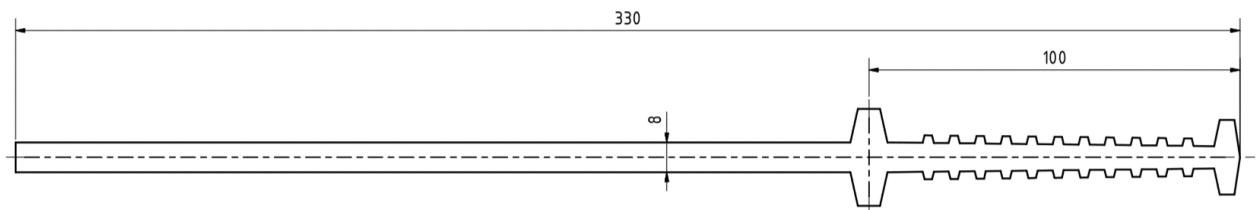

All dimensions in mm

# Data sheet - Clamped waterstop series



FM 350 K

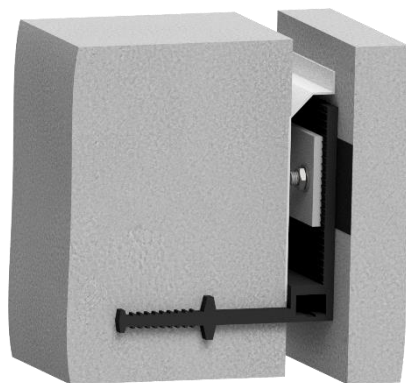
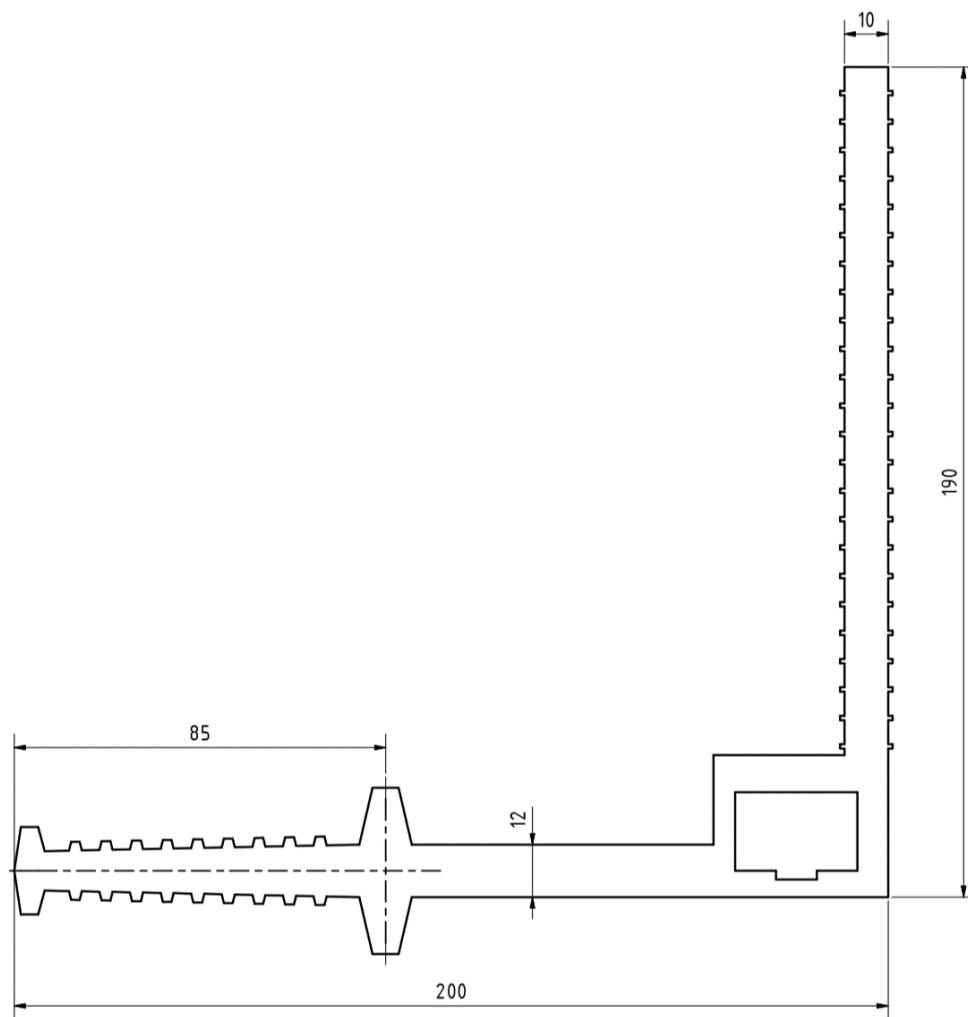

All dimensions in mm

# Data sheet - Clamped waterstop series



FM 500 K

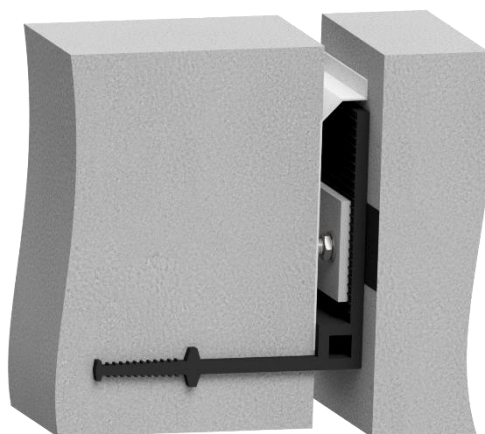
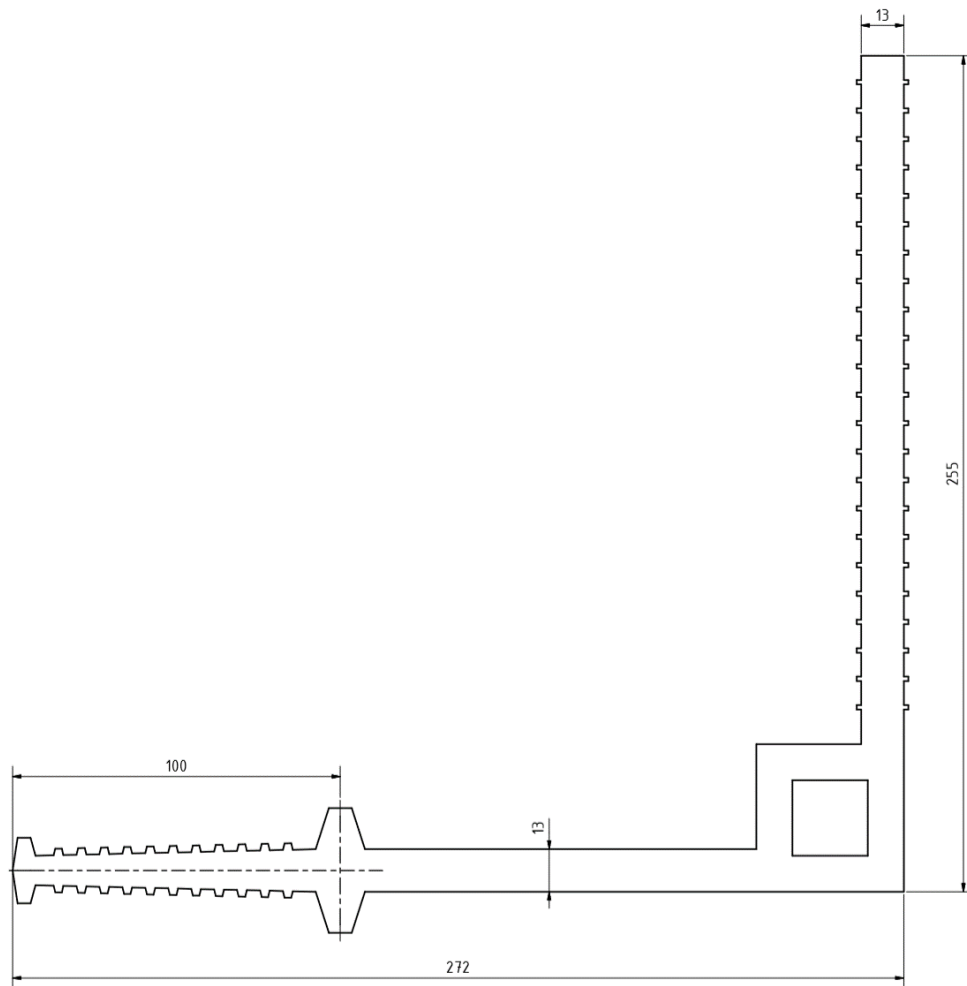

All dimensions in mm

# Data sheet - Clamped waterstop series



FM 350 KF

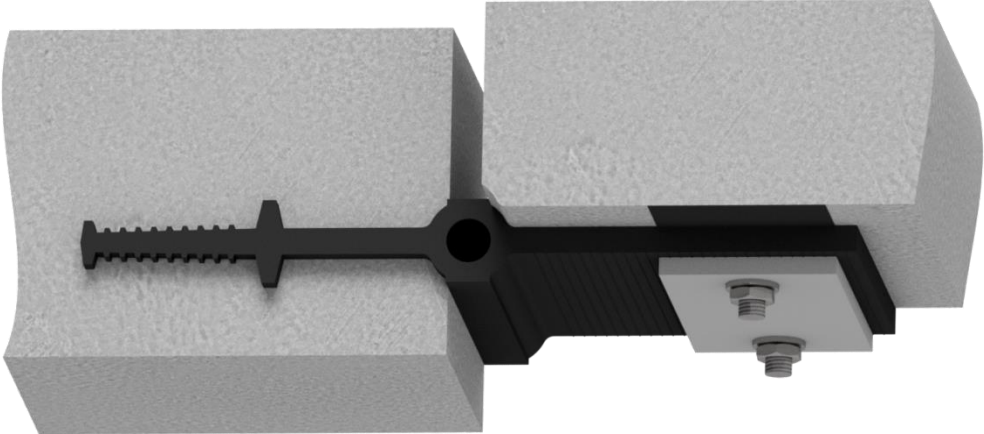
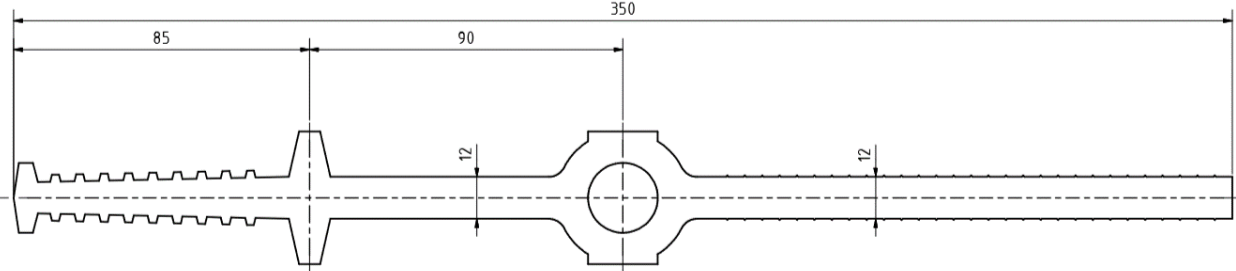

FM 350 KF2

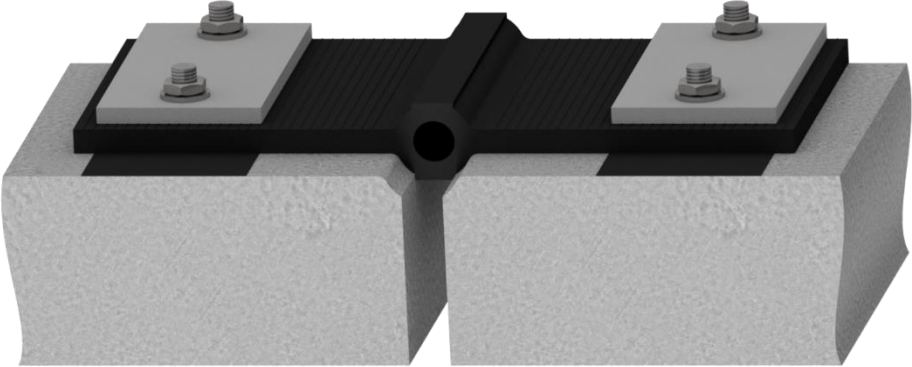
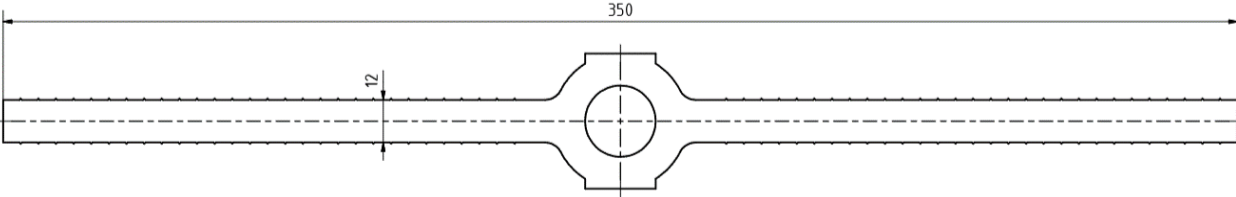

All dimensions in mm

# Data sheet - Clamped waterstop series



AM 350 KI

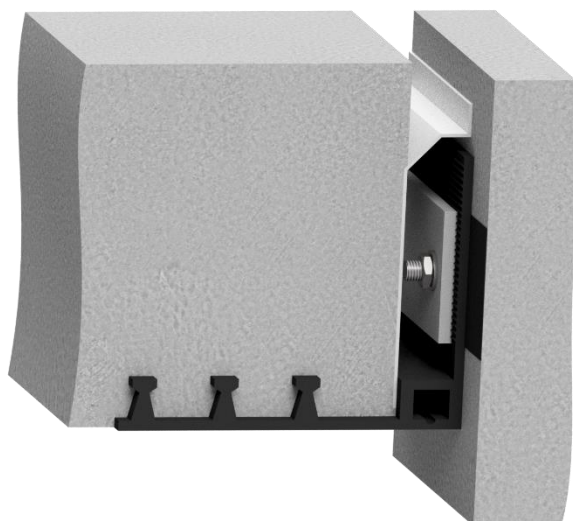
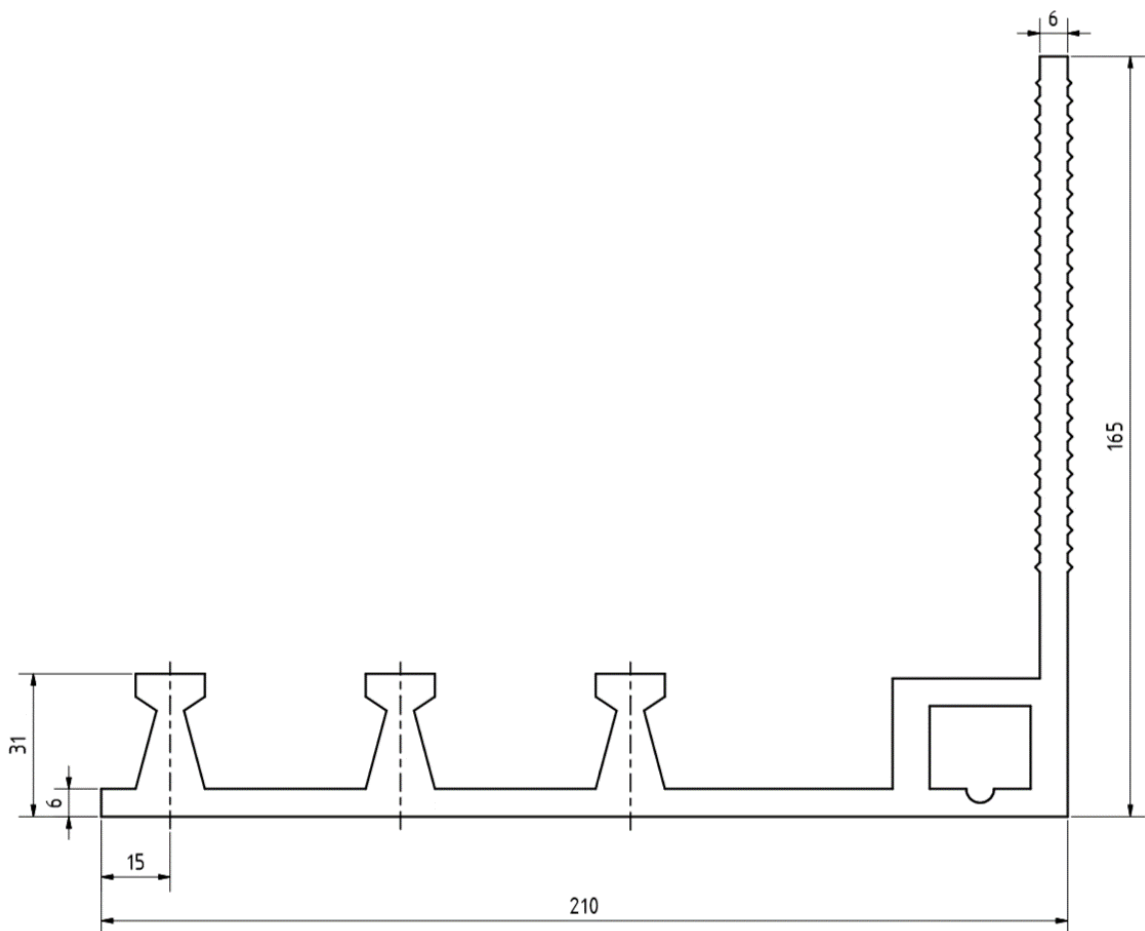

All dimensions in mm



# Data sheet - Clamped waterstop series



AM 350 KA

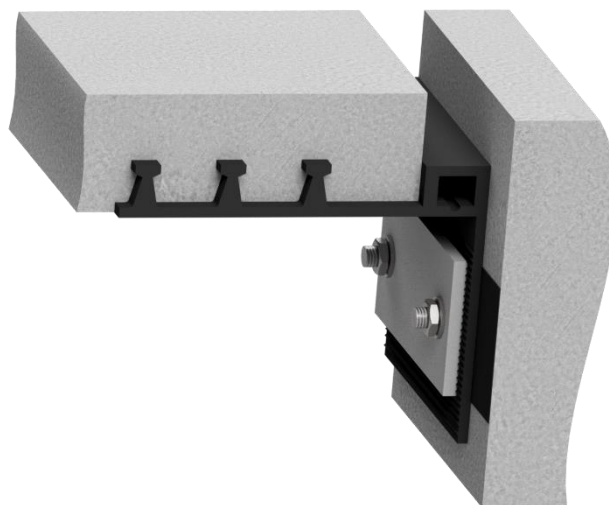
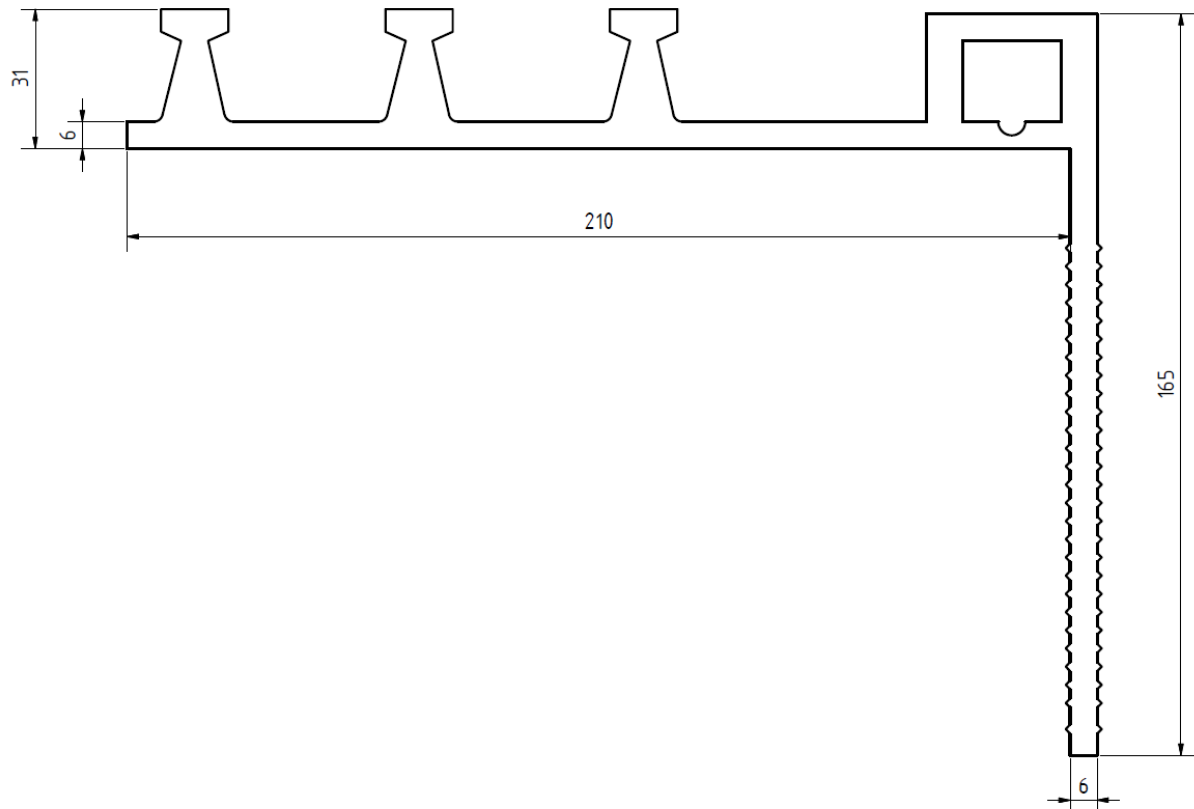

All dimensions in mm

# Data sheet - Clamped waterstop series



AM 350 KF

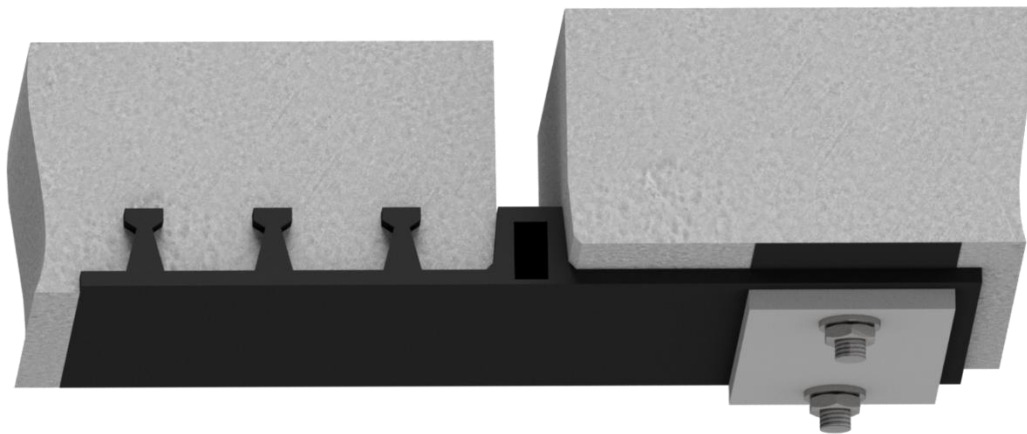
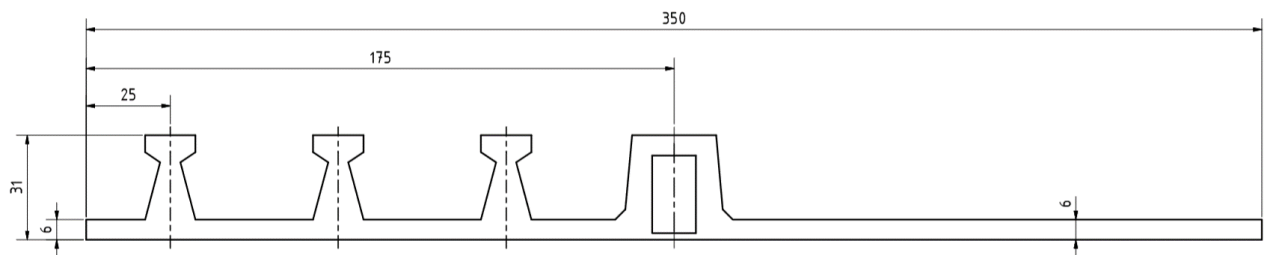

AM 350 KF2

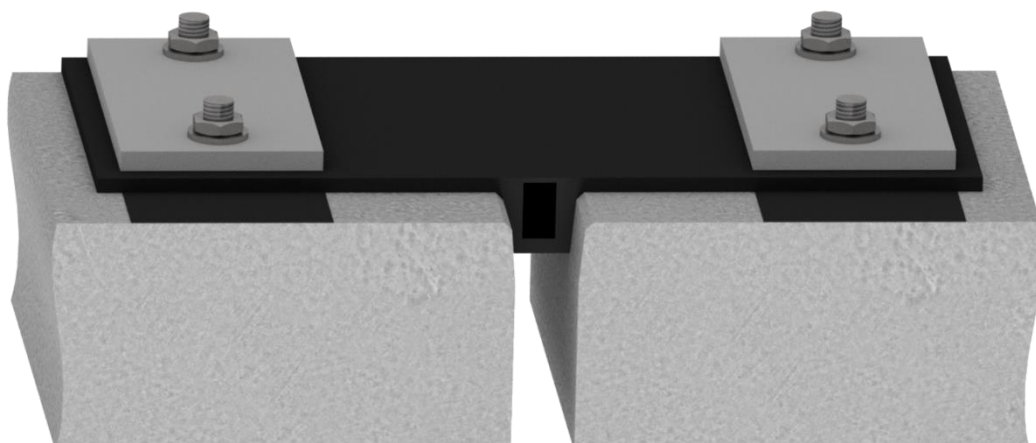
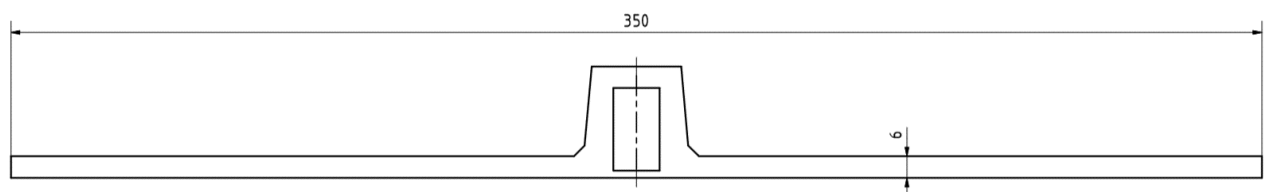

All dimensions in mm

# Data sheet - Clamped waterstop series



AM 350 KFV

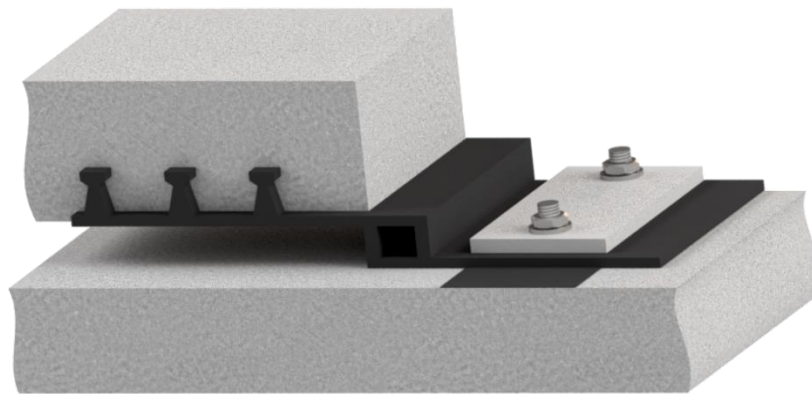
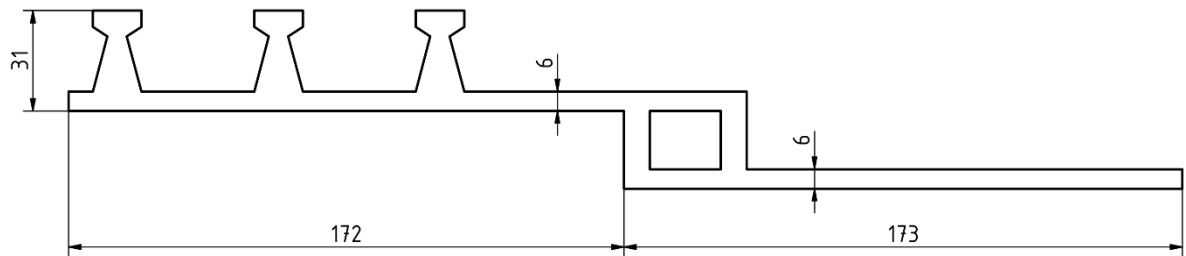

All dimensions in mm

# Data sheet - Clamped waterstop series



AMG 350 Ecke

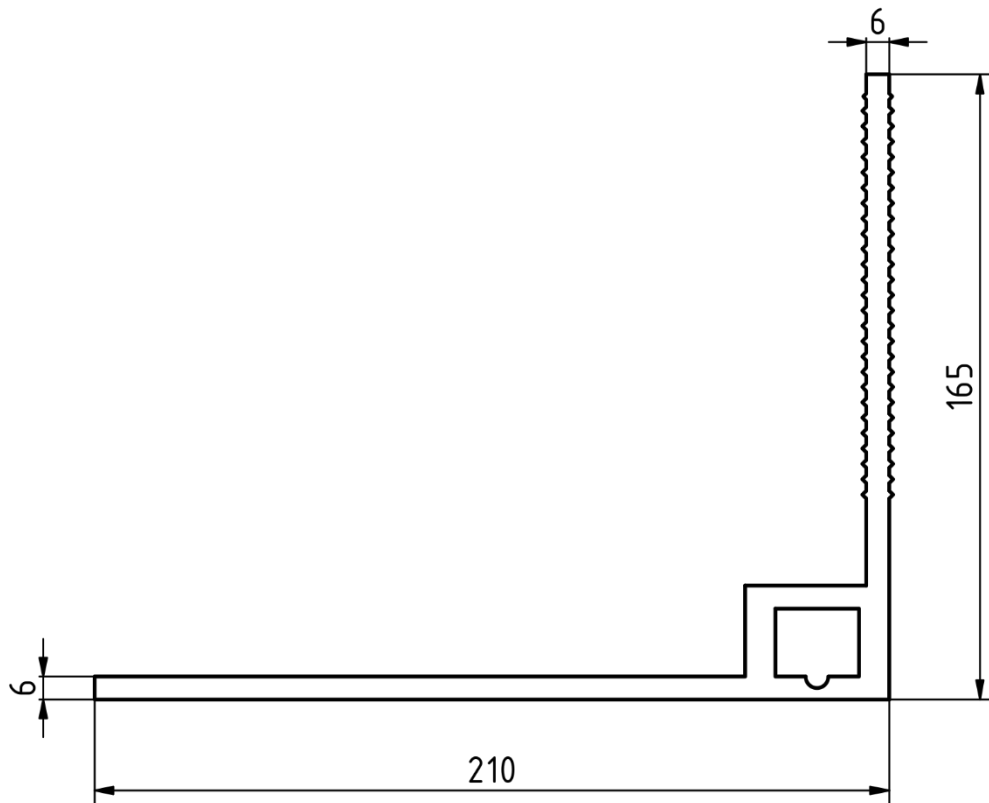

All dimensions in mm

# Data sheet - Clamped waterstop series



FAE 70 mod

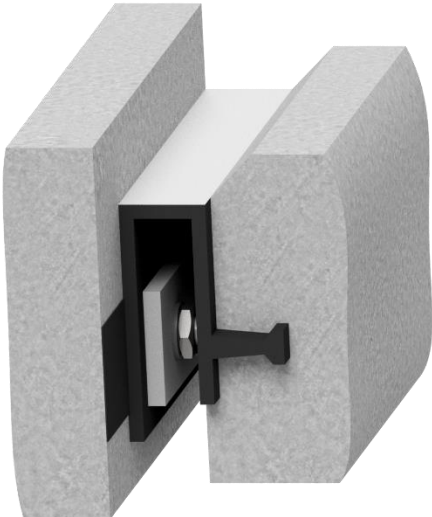
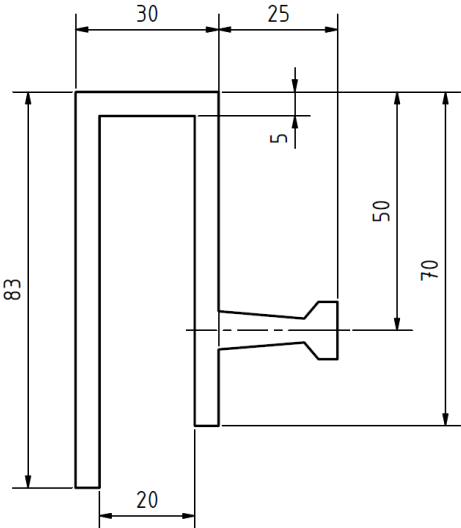

FAE 100 mod

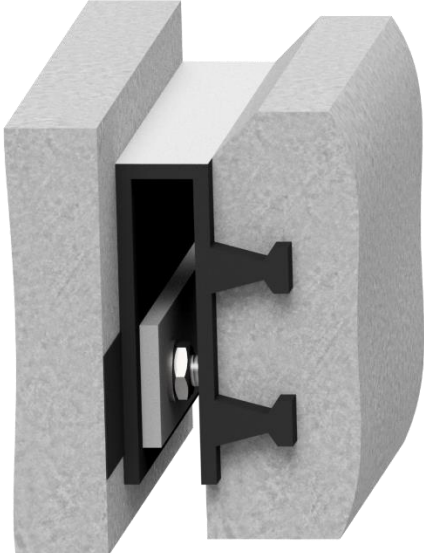
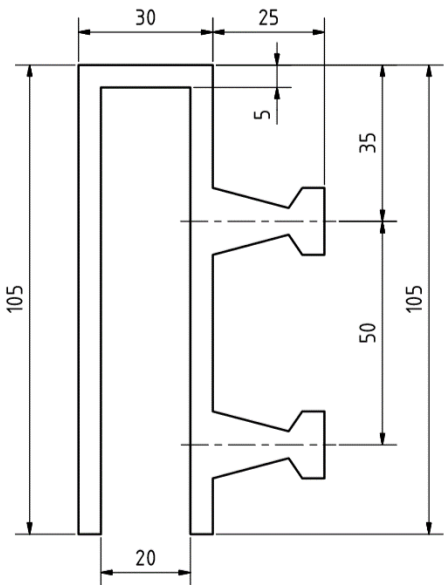

All dimensions in mm

